

THE
WORKSURFACES
COLLECTION

YOUR BOOK OF
INSPIRATION





03

WHITE

- 05 Pure
- 09 Veined
- 19 Speckled

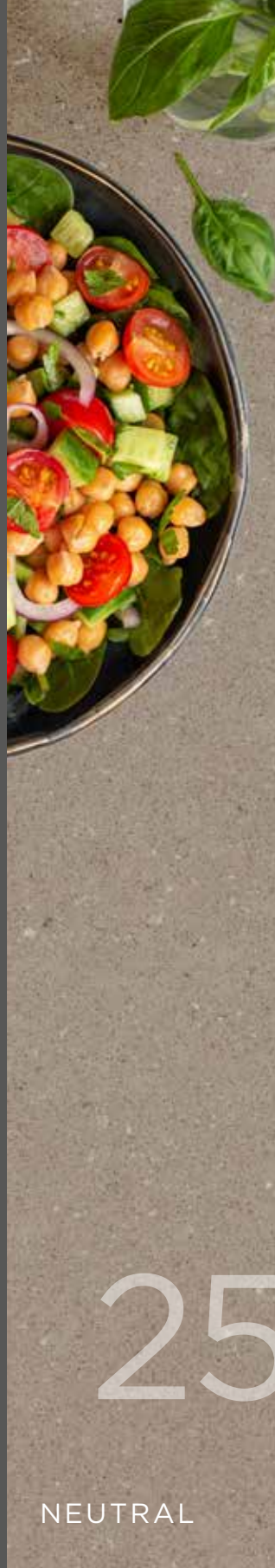

25

NEUTRAL

- 27 Pure
- 31 Veined
- 35 Speckled



39

GREY

- 41 Pure
- 45 Veined
- 49 Speckled

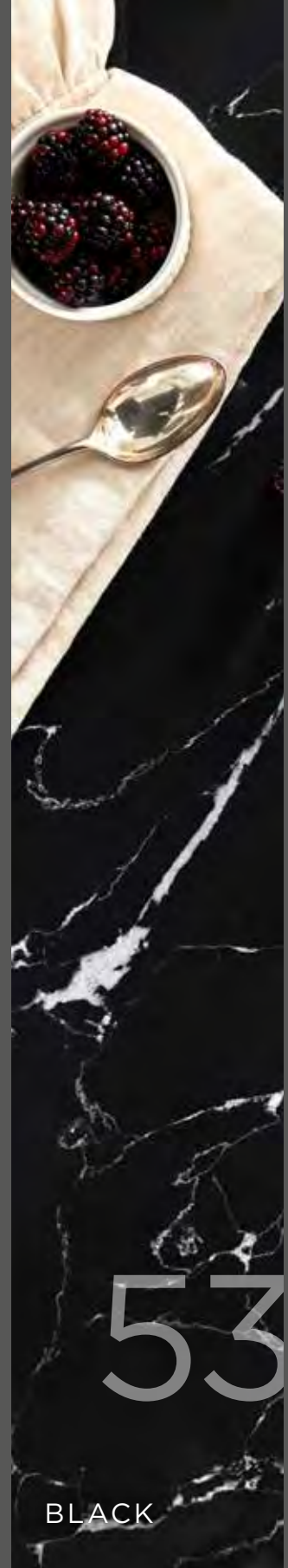

53

BLACK

- 55 Pure
- 57 Veined
- 63 Speckled



67

INDUSTRIAL



75

TIMBER



81

YOUR
WORK
SURFACE

- 83 Characteristics
- 85 Finishes
- 87 Finer Details



A GROUNDING PRESENCE - IN ANY AND EVERY ROOM...

A worksurface has the capability to utterly transform the look and feel of your room. With such a vast collection of textures, materials, and colours at your disposal; our worksurface collection is home to a plethora of looks to suit you and your home, no matter your kitchen style.

With our extensive range, choosing a worksurface is no longer a simple choice of, which colour do you like? Discover what role you would like your

worksurface to play within your design: a striking focal point that immediately captures attention, or a supporting element that complements and allows other interior pieces to shine.

Dive into the world of colour; dare to go bold or opt for something soft and subtle. Explore textures and patterns to unlock your creativity or consider our delicate veining materials for a more

refined look. The design possibilities are endless.

This brochure is lavish in inspiration and ideas to consider before you make your choice. Showcased in carefully curated collections, from Neutral to Black, peruse through our worksurface range complete with the very best materials from around the world.

SEE AN ICON AND NEED A RECAP OF WHAT IT STANDS FOR?
JUST FLIP TO OUR BACK PAGE FOR A BREAKDOWN AND USE IT
AS YOUR BOOKMARK TO MAKE BROWSING EASY.

Note that all of the images you'll see in our bespoke collection are a representation of the real thing. You can expect variations in tone, texture and pattern but that's all part of your worksurface's individuality.



WHITE

COLLECTION

Pure and simple

A timeless option for any kitchen design, be it classic or contemporary, a crisp white work surface instantly brightens a room setting. Evoking images of cool mountain tops, or freshly laid snow, the colour white connotes a sense of calmness and pours this into the room's design palette. Ultimately, creating a welcoming, light space to relax and enjoy.



WHITE
PURE



CREATE THE LOOK

- 1 Worksurface: Strata Granite Sinuous White
- 2 Worksurface: Strata Quartz Brilliant White
- 3 Sink: Kombino 20 Stainless Steel
- 4 Handle: Aluminium Handleless Rail
- 5 Tap: Nobili Aquerelli L Spout Chrome
- 6 Paint Colour: Dove Grey

WHITE PURE

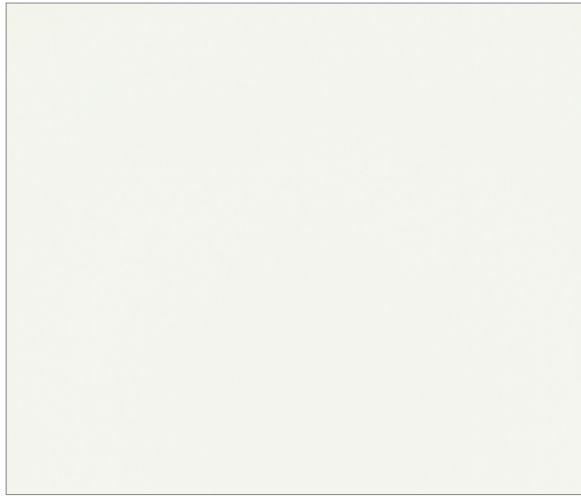

Halo

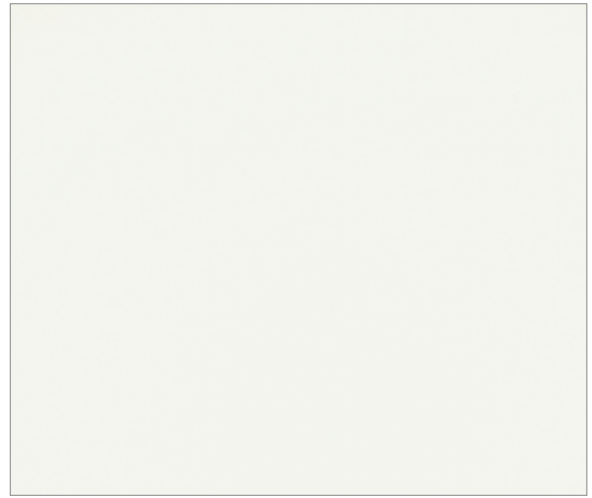

Zenith

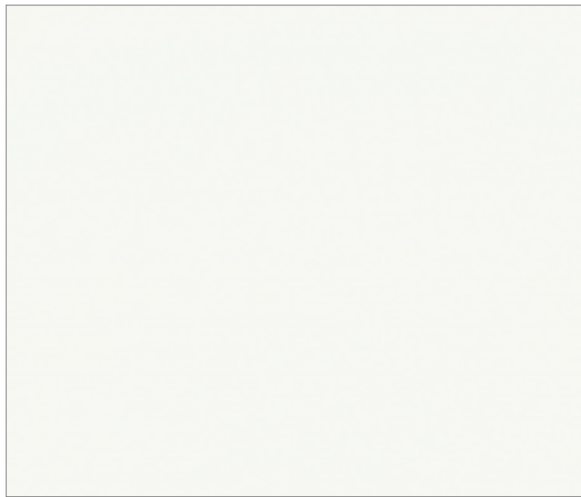

Uyuni

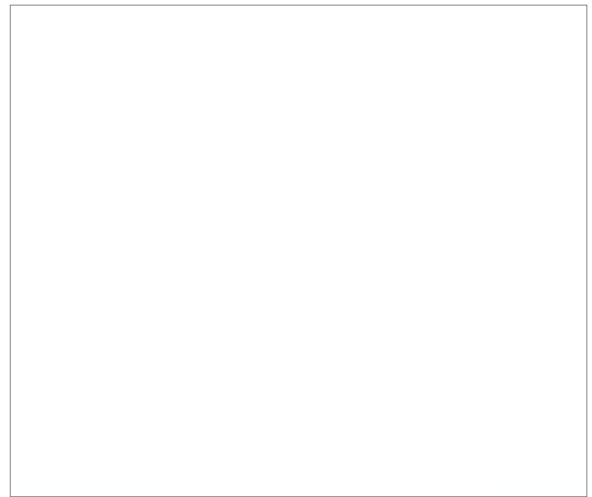

Brilliant White

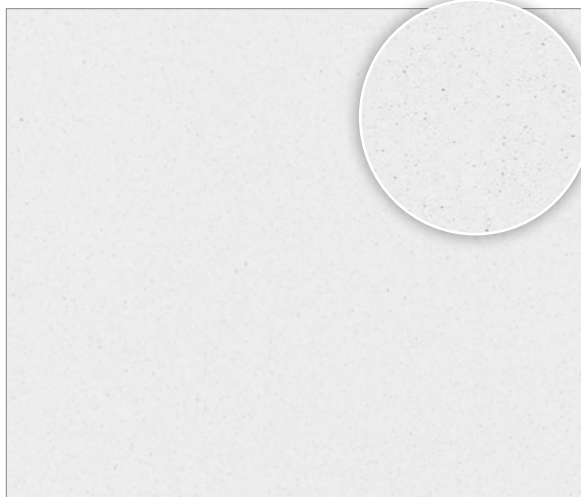

Snowfall



ULTRA COMPACT



QUARTZ



GRANITE



FLIP TO OUR BACK PAGE FOR OUR ICON QUICK GUIDE



Worksurface: Strata Quartz Snowfall



WHITE
VEINED



CREATE THE LOOK

- 1 Worksurface: Strata Ultra HD Khamsin Slab
- 2 Handle: Bloomfield T Handle in Antique Bronze
- 3 Door: Crathorne in Taupe Grey
- 4 Tap: Nobili P-shape Bronze Tap



Worksurface: Strata Calacatta Platinum

WHITE VEINED COLLECTION



Helena



Lagoon



Neural



Speak to us about an alternative finish

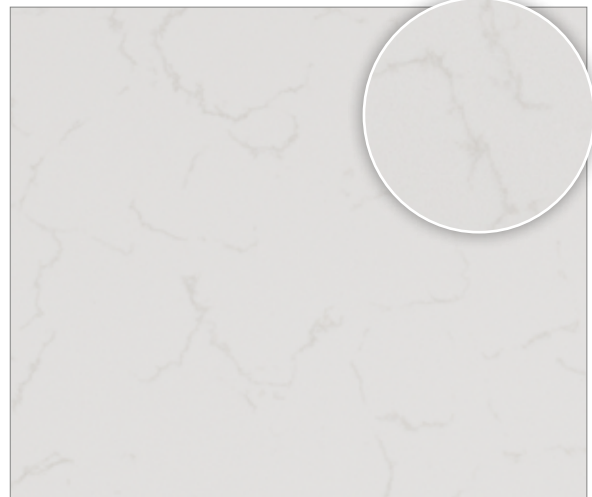

Marbled White

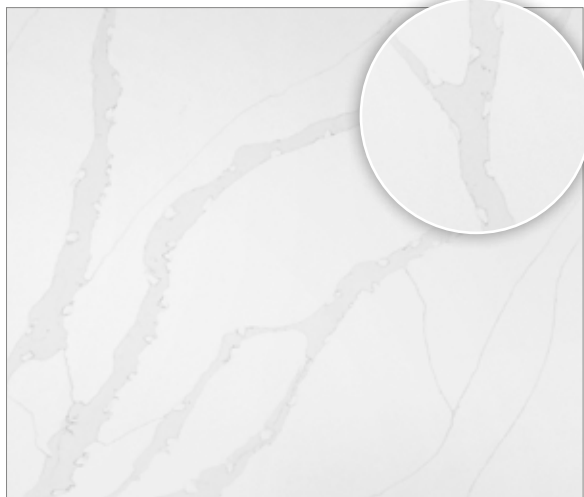

Strata Calacatta Platinum



Strata Calacatta Silver



GRANITE
 QUARTZ
 ULTRA COMPACT

FLIP TO OUR BACK PAGE FOR OUR ICON QUICK GUIDE

WHITE VEINED COLLECTION



Pietra Cloud

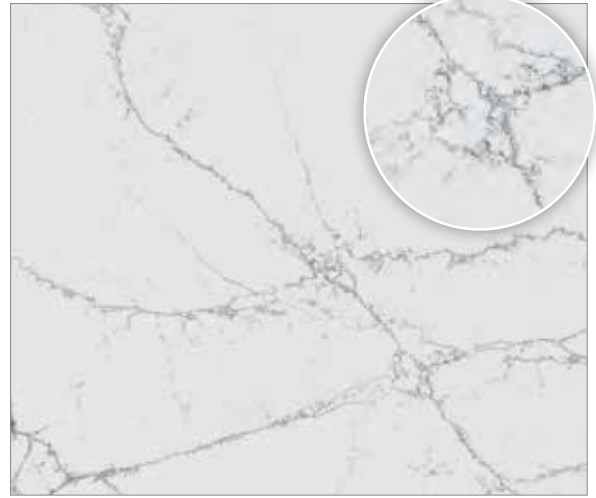

Pietra Icy White



Absolute Marbled White

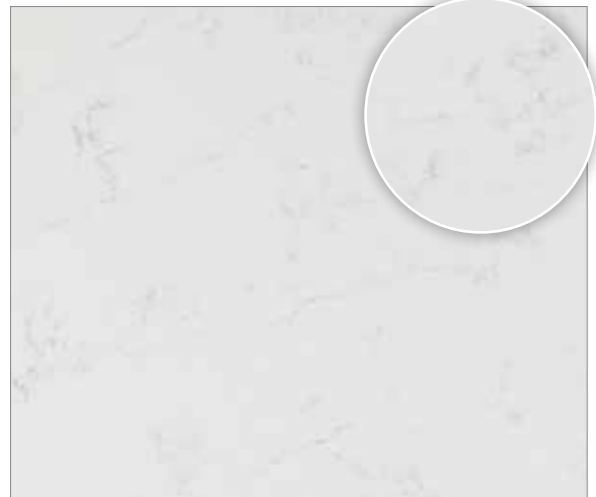

Strata Carrara Gioia

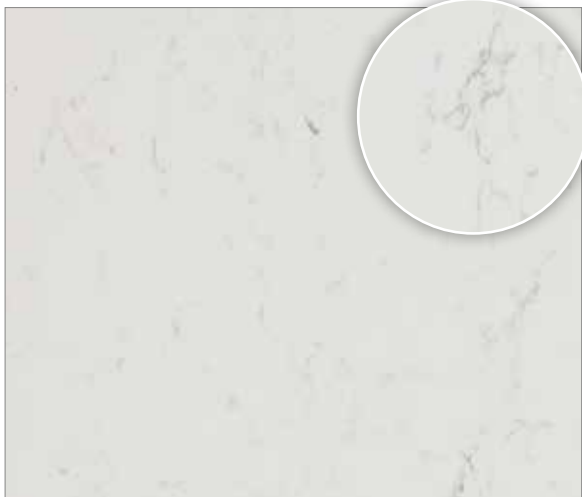

Strata Imperial



Rem



ULTRA COMPACT

QUARTZ

GRANITE



Opera



Aura



Strata Calacatta Gold



Lucid



Speak to us about an alternative finish



Eclectic Pearl



Ethereal Glow



WHITE VEINED COLLECTION



Ethereal Haze



Grigio Corchia

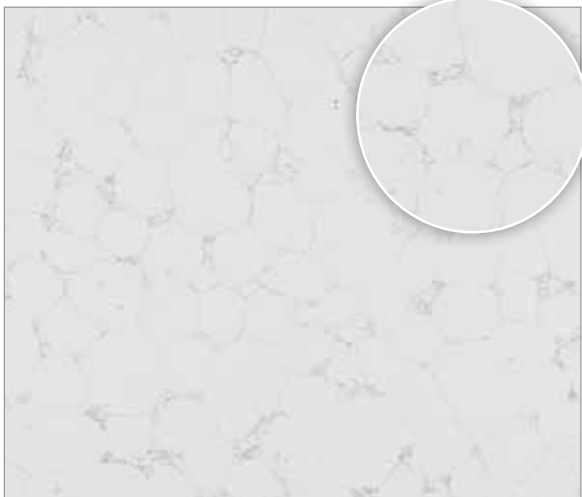

White Venato



Versailles Ivory

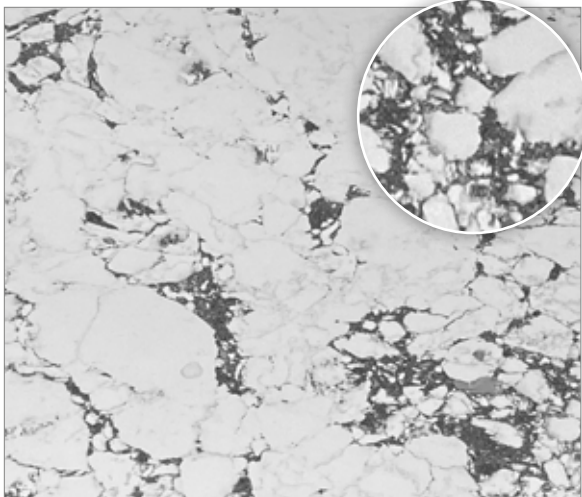

Arabietto Bianco



Entzo



ULTRA COMPACT

QUARTZ

GRANITE



Lusso



Rosa Astratto

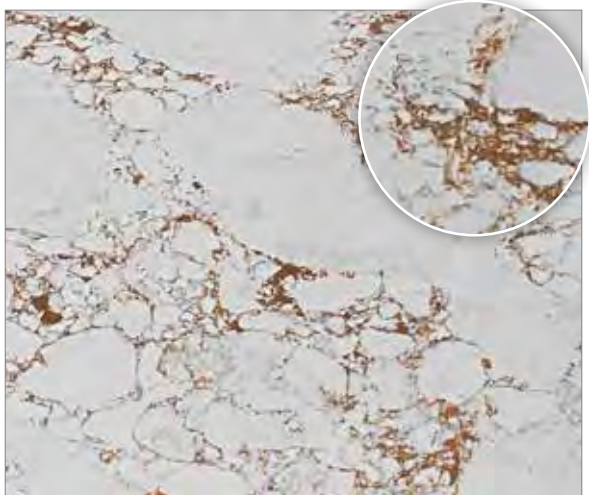

Ferro Corchia



Awake



Ultra HD Quartz Khamsin



Nera Astratto



WHITE VEINED COLLECTION

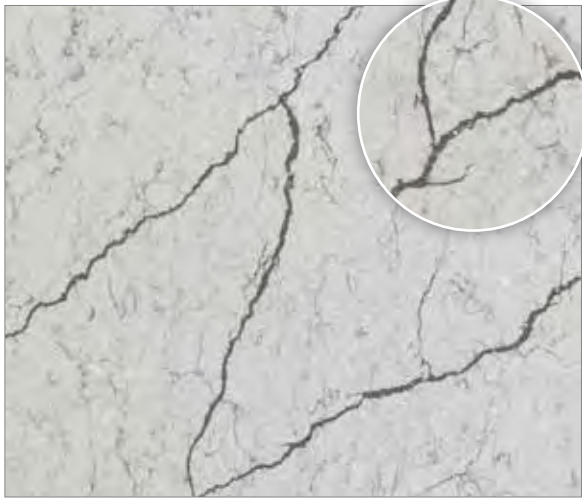

Strata Perlatino

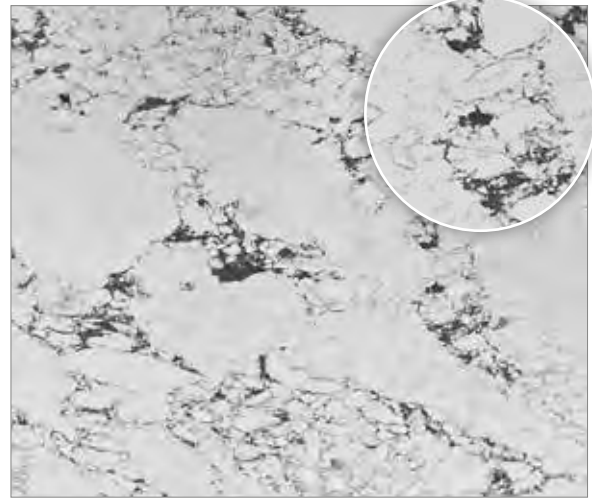

Grafite Corchia

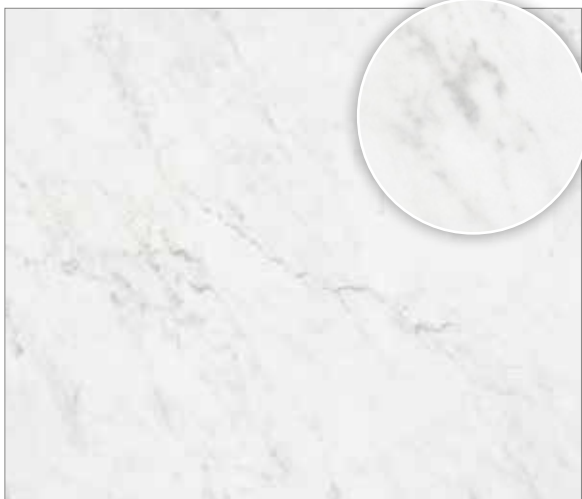

Marina



Ultra HD Quartz Odyssey



Trance



Bergen



ULTRA COMPACT

QUARTZ

GRANITE

FLIP TO OUR BACK PAGE FOR OUR ICON QUICK GUIDE





WHITE
SPECKLED



CREATE THE LOOK

- 1 Worksurface: Strata Granite Super White Eclipse
- 2 Door Range: Unity Natural Oak Montane
- 3 Tap: Nobili Live L Spout Chrome
- 4 Sink: Kombino 120 Stainless Steel
- 5 Door Range: Unity Taupe Grey Supermatt



Worksurface: Super White Eclipse showing ribbed surface detail

WHITE SPECKLED COLLECTION



Nolita



Yukon



Super White Eclipse



Elegant Cream



Worksurface: Strata Quartz Elegant Cream

FLIP TO OUR BACK PAGE FOR OUR ICON QUICK GUIDE

WHITE SPECKLED COLLECTION

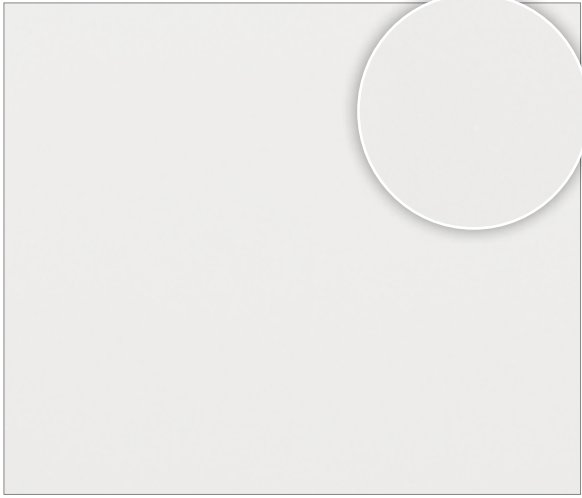

Morning Frost



Materials contains sparkle elements



Quartz Mirror



Blanco Maple



Faro White



ULTRA COMPACT



QUARTZ



GRANITE



Arctic Storm



Colonial White



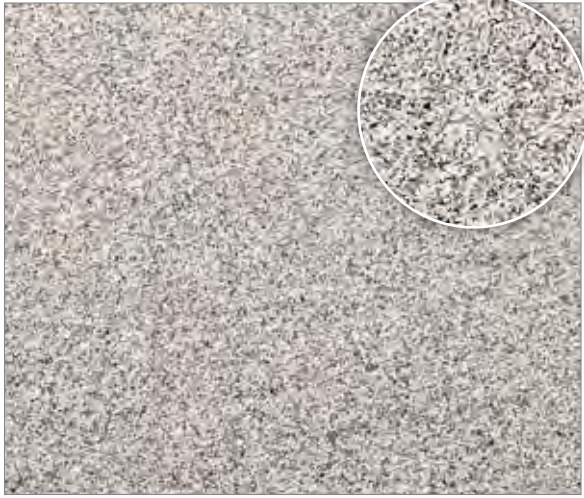

Bianco Sardo



Ice Blue



Sinuous White



Worksurface: Strata Granite Sinuous White

FLIP TO OUR BACK PAGE FOR OUR ICON QUICK GUIDE



NEUTRAL

COLLECTION

Nature's canvas

A palette of sophisticated taupe, putty and biscuit-like beiges, these tactile surfaces are a reflection of nature's most grounding shades. Curated to mirror a selection of minerals and stones, from textured clay to ribboned marble, in situ they promise a warm, calming presence and make fine company for flagstones and timber floorboards.



NEUTRAL
PURE



CREATE THE LOOK

- 1 Worksurface: Dekton Ultra Compact Dunna
- 2 Handle: Didsbury Knob Stainless Steel
- 3 Tap: Nobili Flag J Spout Stainless
- 4 Door Range: Belsay Woodgrain in Reed Green
- 5 Paint Colour: Stone

NEUTRAL PURE COLLECTION



Dunna



PURE NEUTRAL

Dunna presents a creamy neutral shade for an effortlessly elegant worksurface in your kitchen design. It's muted tone and subtle style calls for the opportunity to blend additional colours and textures throughout the space, making it an ultra-flexible material in modern and traditional settings alike.

- 1 Worksurface: Dekton Dunna
- 2 Door Range: Belsay Woodgrain in Reed Green & Porcelain
- 3 Handle: Didsbury Knob Stainless Steel



3



NEUTRAL
VEINED



CREATE THE LOOK

- 1 Worksurface: Dekton Ultra Compact Taga
- 2 Door Range: Hunton in Porcelain
- 3 Tap: Nobili Live U Spout Matt Black

NEUTRAL VEINED COLLECTION



Arga



Sandik



Marmorio



Ivory Fantasy

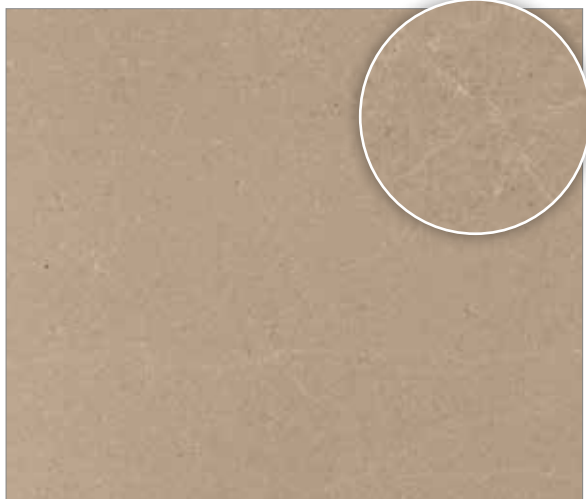

Pietra Taupe



Adia



ULTRA COMPACT

QUARTZ

GRANITE

FLIP TO OUR BACK PAGE FOR OUR ICON QUICK GUIDE



Nebu



Trevi



Pietra Auburn



Worksurface: Dekton Ultra Compact Marmorio



NEUTRAL
SPECKLED



CREATE THE LOOK

- 1 Worksurface: Strata Quartz Patagonia showing ribbed surface detail
- 2 Tap: Nobili Move Semi-Pro Matt Black
- 3 Sink: Quadrix 50 Twilight
- 4 Door Range: Porter in Taupe Grey
- 5 Handle: Champagne Handleless Rail

NEUTRAL SPECKLED COLLECTION



Polar



Danae



Sabbia Dekton

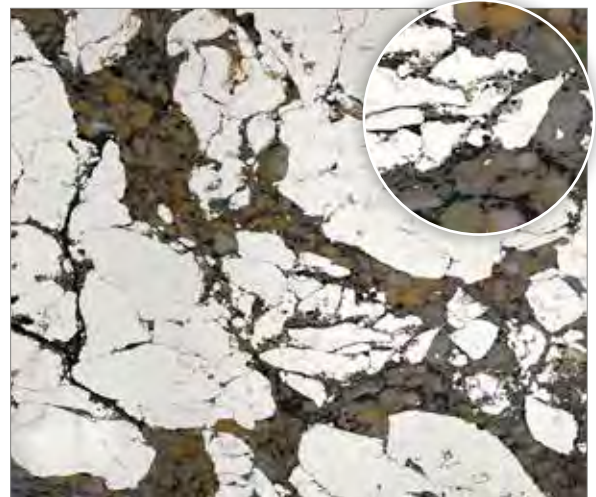

Patagonia



Hail Storm



Ceppo



ULTRA COMPACT

QUARTZ

GRANITE



Khalo



Ava

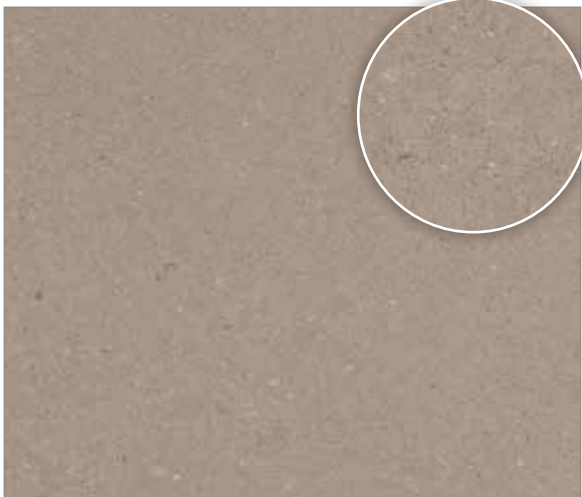

Elegant Clay

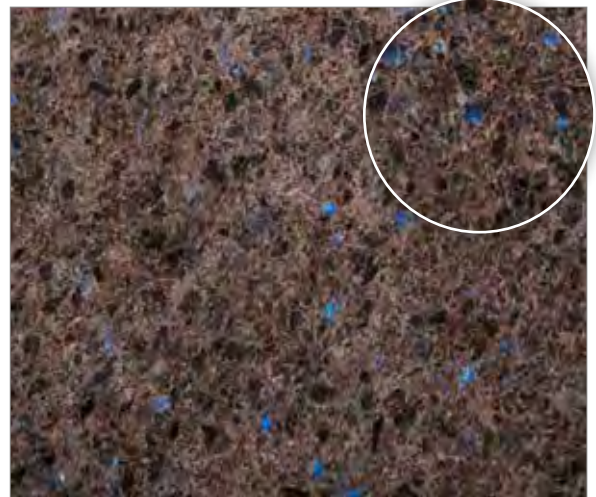

Lundhs Antique



Worksurface: Dekton Ceppo



GREY

COLLECTION

For subtle drama

Our grey collection of worksurfaces encompasses a plethora of tones, textures, and styles to suit any interior. Embracing the natural beauty of stone and speckled characteristics, this collection expertly balances the effortless beauty of delicate veined slabs, whilst offering deep, luxe tones for a more glamorous look.



GREY
PURE



CREATE THE LOOK

- 1 Worksurface: Dekton Ultra Compact Micron
- 2 Door Range: Unity Haywood Concrete
- 3 Tap: Nobili Live J Spout Matt Black
- 4 Sink: Atox 50 Carbon
- 5 Door Range: Unity in Indigo Blue Supermatt

GREY PURE COLLECTION

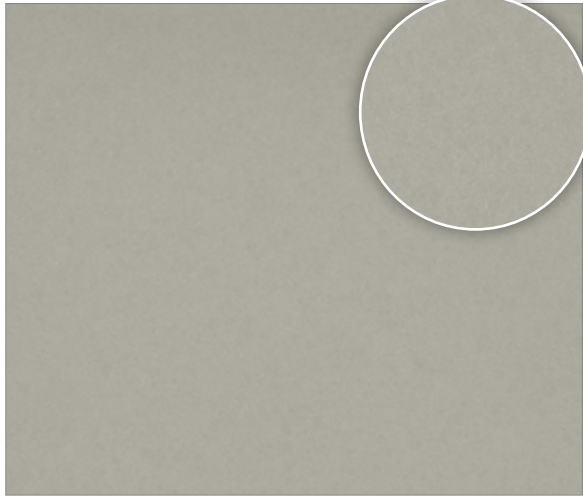

Cinzel Grey

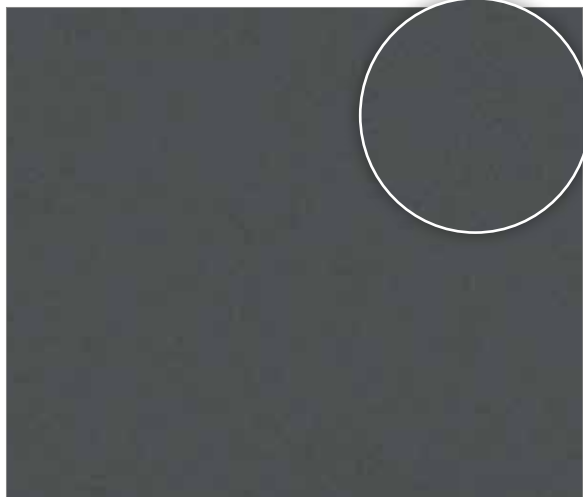

Marengo

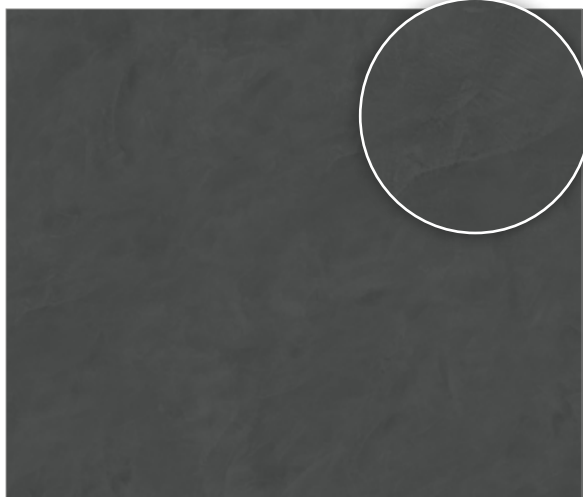

Micron



ULTRA COMPACT



QUARTZ



GRANITE

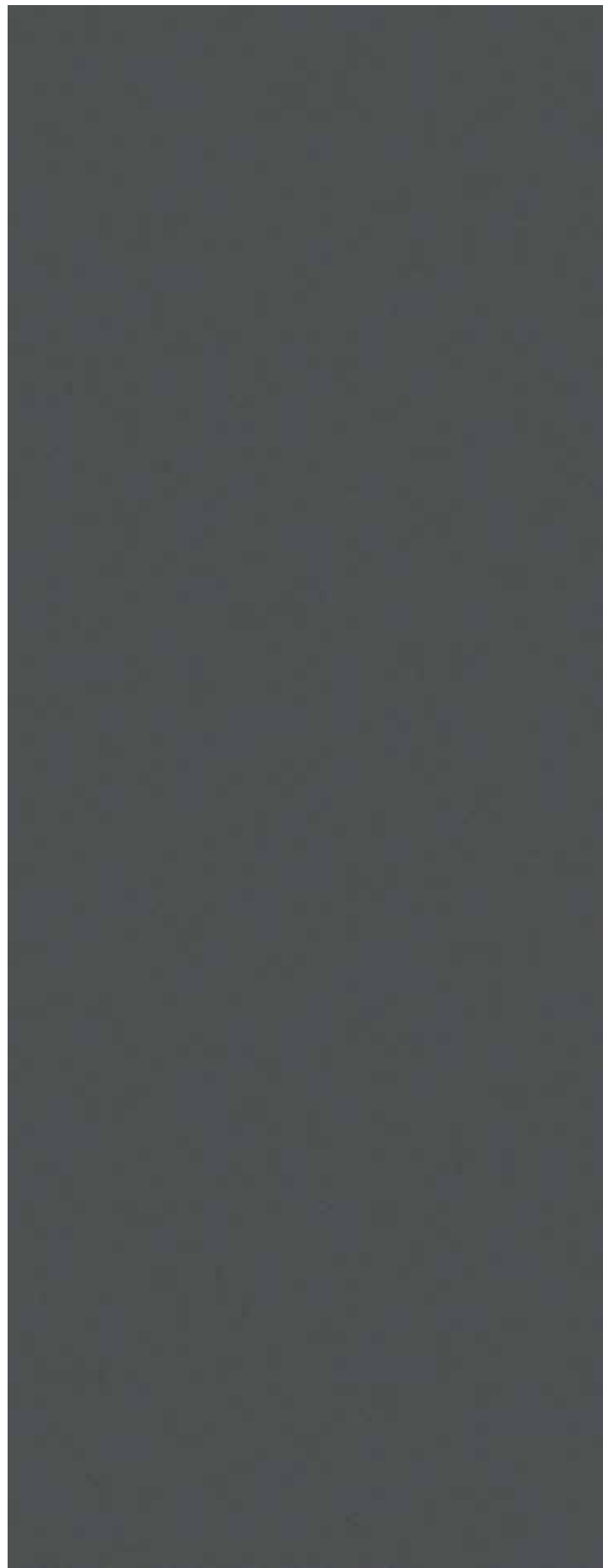



Worksurface: Silestone Hybriq Marengo



GREY
VEINED



CREATE THE LOOK

- 1 Worksurface: Ultra HD Quartz Tempest
- 2 Sink: Kombino 20 Stainless Steel
- 3 Paint Colour: Regiment
- 4 Tap: Nobili Heron Semi-Pro Chrome & Matt Black
- 5 Door Range: Mornington Beaded in Taupe Grey

GREY VEINED COLLECTION



Worksurface: Ultra HD Quartz Tempest



Desert Silver

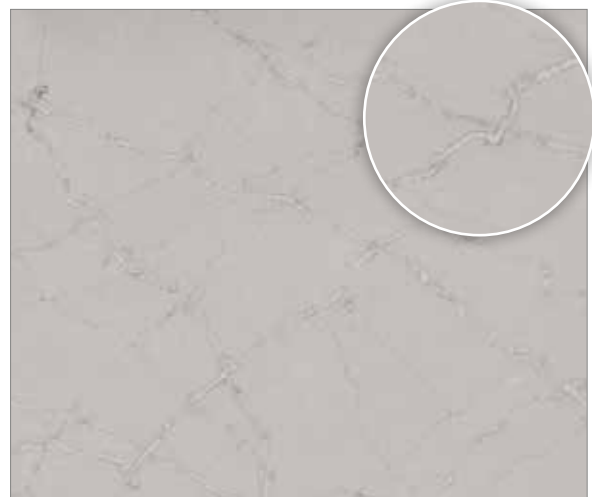

Victorian Silver

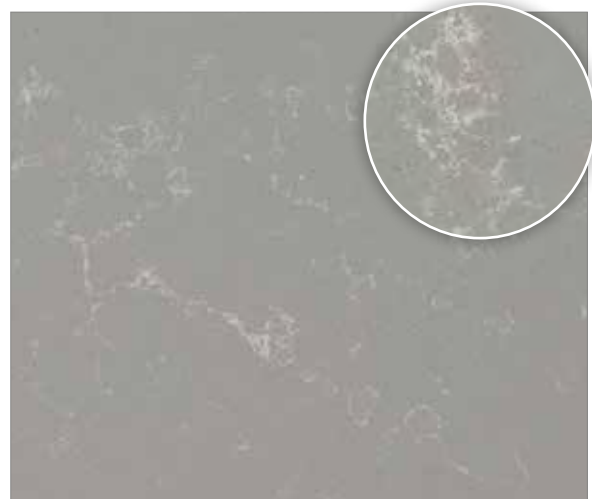

Marbled Grey



ULTRA COMPACT

QUARTZ

GRANITE



Pietra Silver

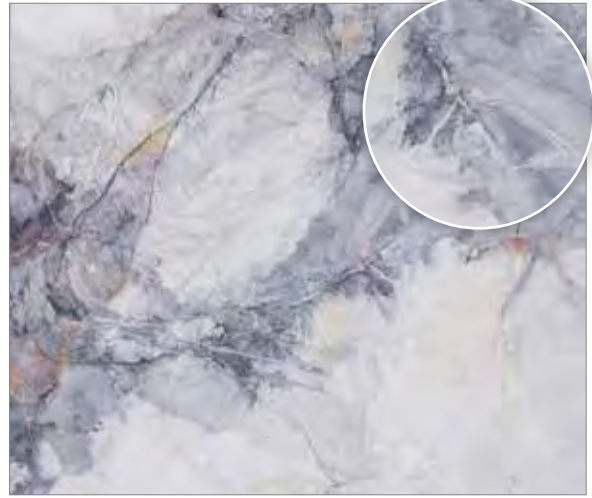

Ultra HD Quartz Tempest



Azul Aran



Parisien Bleu



Charcoal Soapstone



Pietra Charcoal



FLIP TO OUR BACK PAGE FOR OUR ICON QUICK GUIDE



GREY

SPECKLED



CREATE THE LOOK

- 1 Worksurface: Strata Quartz Crystal Grey
- 2 Worksurface: Strata Granite Premium Black
- 3 Tap: Nobili Sorgente Bolle Matt Black
- 4 Handle: Lloyd Matt Black

GREY SPECKLED COLLECTION

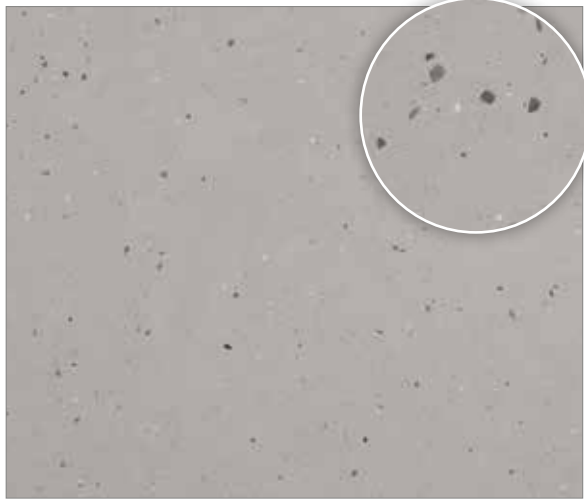

Concrete Pulse

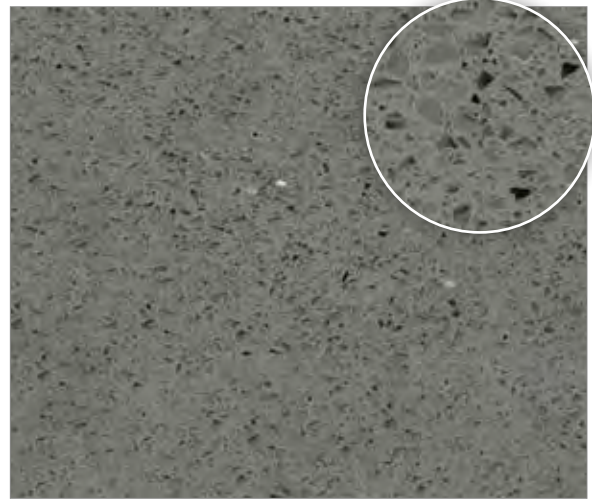

Grey Mirror



Gris Sylvestre

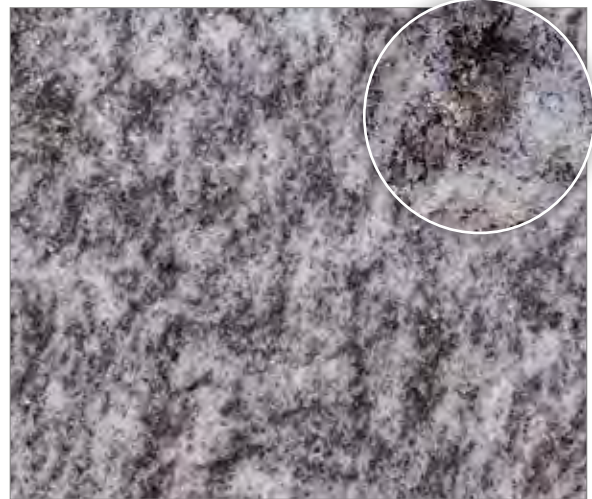

Moon Pearl

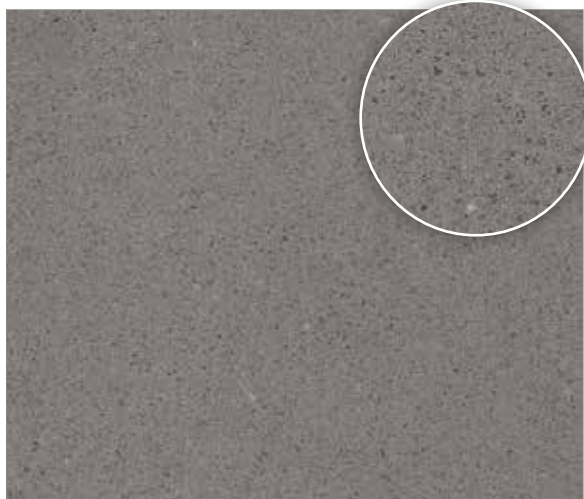

Crystal Grey

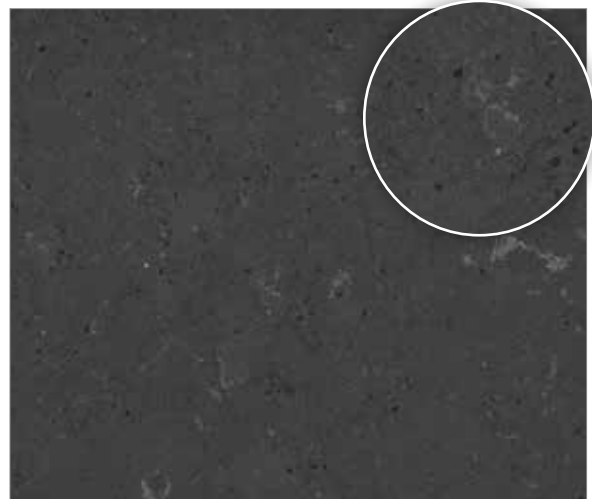

Cinder Craze



ULTRA COMPACT

QUARTZ

GRANITE

FLIP TO OUR BACK PAGE FOR OUR ICON QUICK GUIDE



Worksurface: Strata Granite Moon Pearl



BLACK

COLLECTION

Be bold with black

The Black Collection hosts a diverse collective of shades, some subtle and brooding with deep hues, others striking with eclectic tones of copper and amber running through. Delicate patterns like veining and speckled details bring a soft-natured element and diverge from the designs that make a bold statement. Due to its versatility, black worksurfaces hold a place across a breadth of looks; from monochrome to industrial, even trending interiors such as Japandi.

BLACK PURE COLLECTION

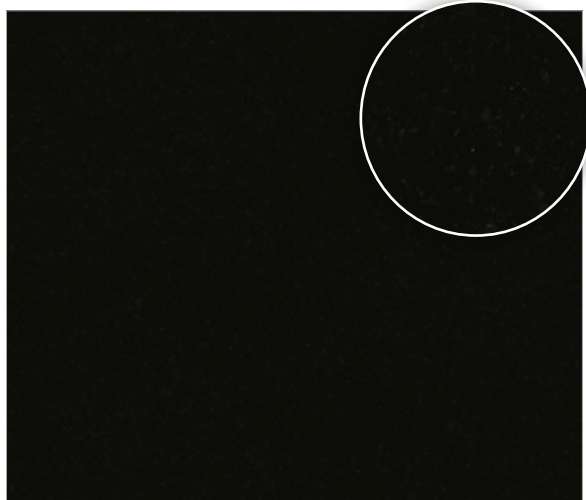

Premium Black

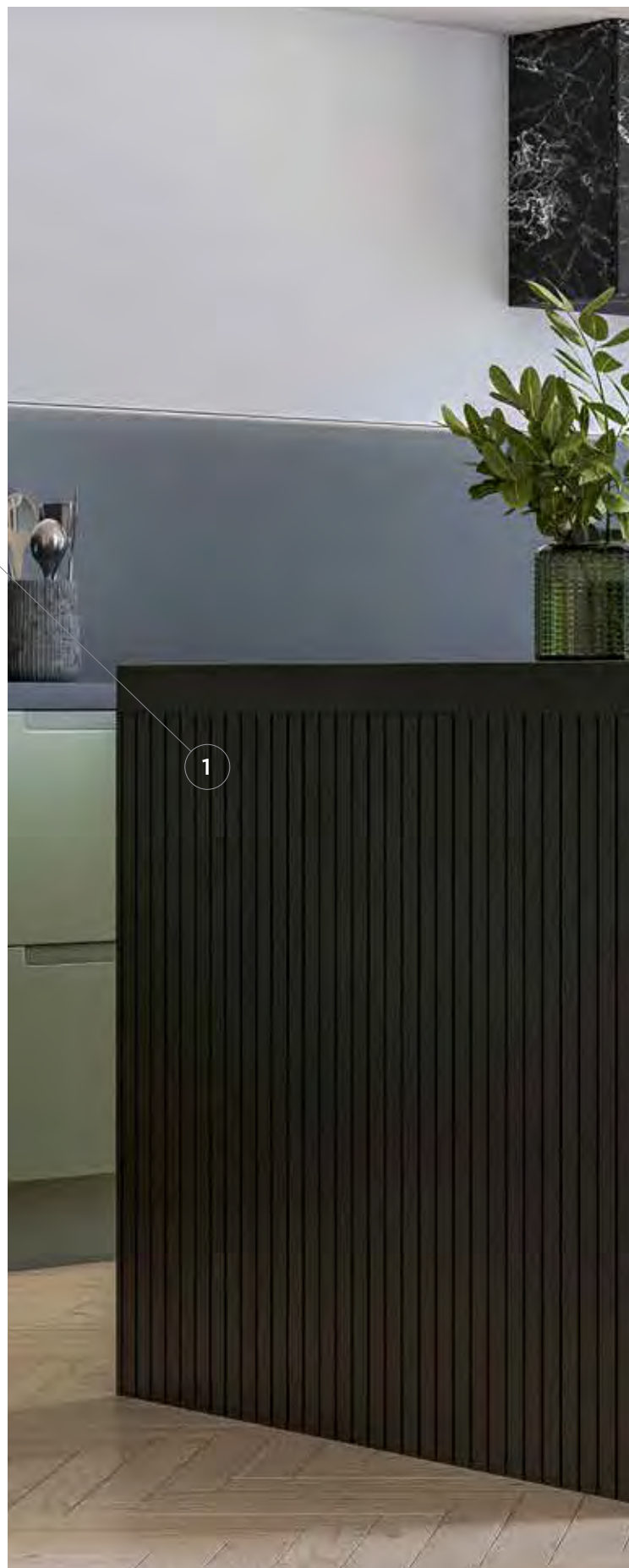

PURE BLACK

Pure black worksurfaces omit pattern and detail for a simplistic, sleek style that effortlessly blends to an interior, whether that be classic or modern. Its stripped-back aesthetic creates the perfect canvas to not only bring depth but also set the tone for the encompassing room. Apply reeded textures, as shown, for a bold monochromatic look, or pair with a softer colour palette for an equally desirable design.

- 1 Worksurface: Strata Granite Premium Black with ribbed surface detail
- 2 Tap: Nobili Move Semi-Pro Chrome
- 3 Door Range: Unity Black Marquina
- 4 Door Range: Remo in Matt Regiment





BLACK
VEINED



CREATE THE LOOK

- 1 Worksurface: Strata Granite Silver Waves
- 2 Sink: Variant 10 Stainless Steel
- 3 Handle: Linton Bar Handle Chrome
- 4 Door Range: Hunton in Dove Grey
- 5 Tap: Nobili Live J Spout Chrome

BLACK VEINED COLLECTION



Pietra Verde



Bohemian Flame



Romantic Ash



Kelya

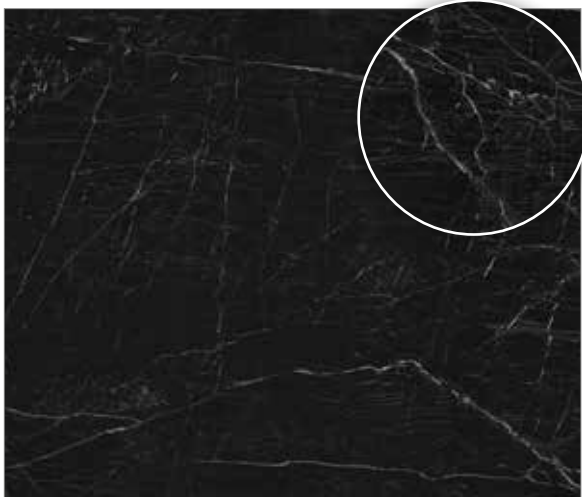

Somnia



Pietra Carbon



ULTRA COMPACT

QUARTZ

GRANITE



Worksurface: Pietra Carbon



Worksurface: Dekton Ultra Compact Laurent

BLACK VEINED COLLECTION

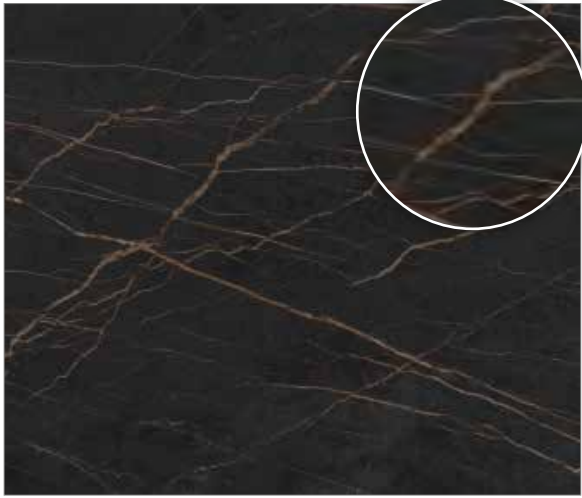

Laurent



Silver Waves



Speak to us about an alternative finish



Black Beauty

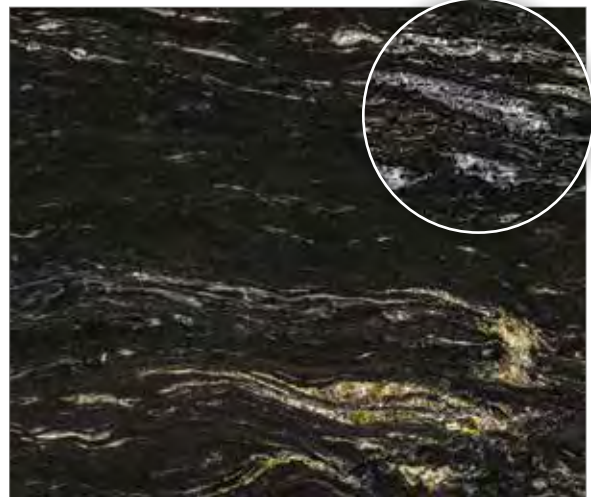

Black Cosmic



Speak to us about an alternative finish

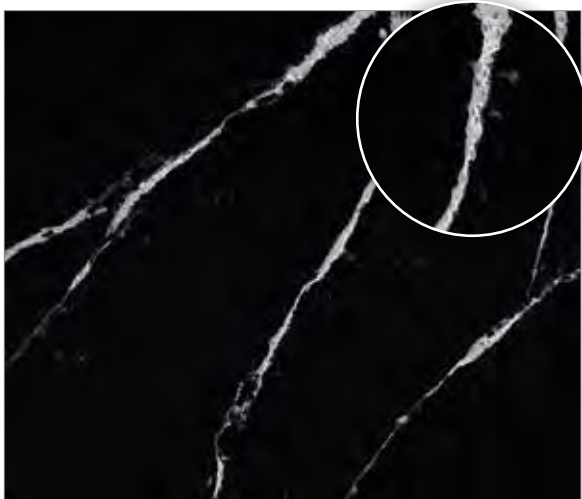

Eternal Marquina

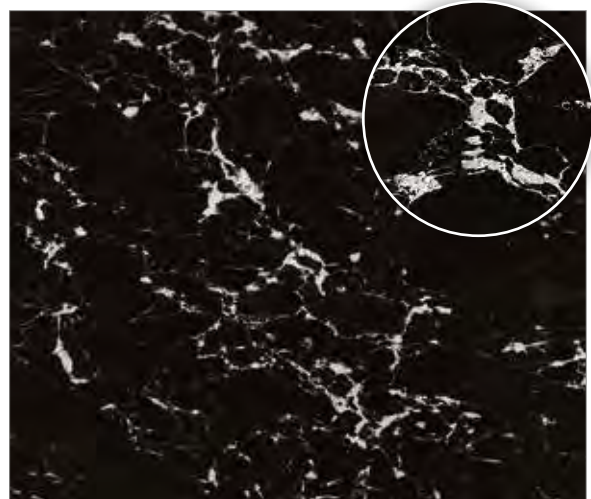

Arabieto Noir





BLACK
SPECKLED



CREATE THE LOOK

- 1 Worksurface: Strata Granite Steel Grey
- 2 Worksurface: Dekton Ultra Compact Aura
- 3 Handle: Barton Knob Chrome
- 4 Tap: Nobili Grazia Chrome
- 5 Sink: Quadrix 50 Artic
- 6 Paint Colour: Stone

BLACK SPECKLED COLLECTION

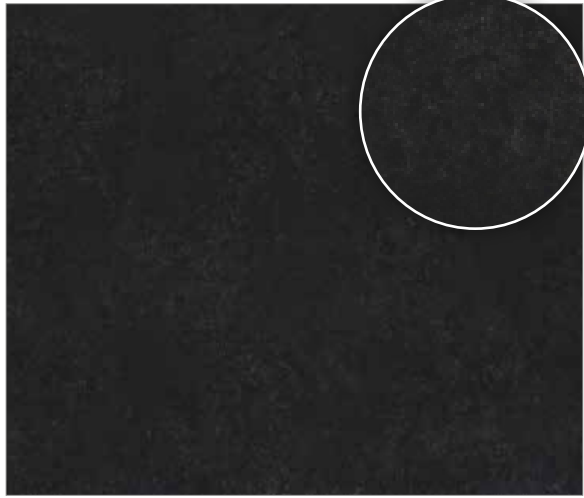

Corktown



Lundhs Blue



Steel Grey

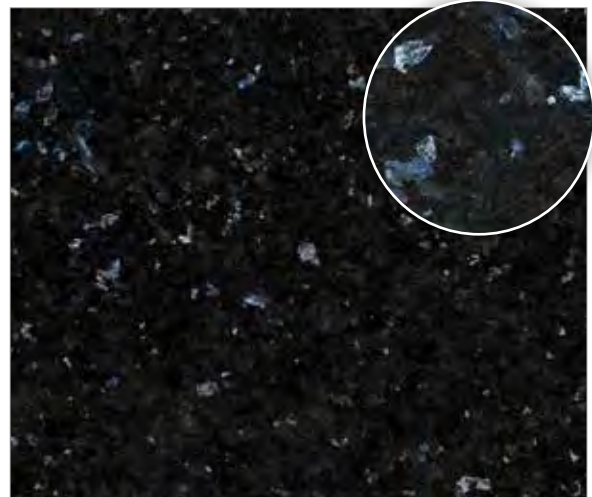

Lundhs Emerald

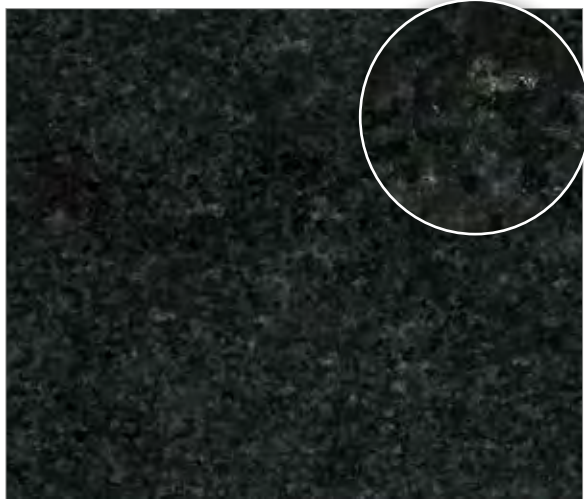

Indian Black Pearl



Ebony



ULTRA COMPACT

QUARTZ

GRANITE

FLIP TO OUR BACK PAGE FOR OUR ICON QUICK GUIDE



Worksurface: Lundhs Blue



INDUSTRIAL

COLLECTION

The new industrial

This collection reflects the transformation of the industrial aesthetic within the interiors world; incorporating luxe metallics and warmer tones for a softer edge to the typically masculine-structured style. With such a diverse and meticulously curated range, your worksurface can be a key focal point in your design with a striking and bold look. Or you can select a more subtle and understated material to elevate the natural architectural elements within the room.





INDUSTRIAL



CREATE THE LOOK

- 1 Worksurface: Silestone Seaport
- 2 Tap: Nobili Live L Spout Chrome
- 3 Handle: Outline Extended Channel with a Walnut Backplate
- 4 Door: Porter in Carbon
- 5 Sink: Variant 40 Anthracite

INDUSTRIAL COLLECTION



Kemble Concrete

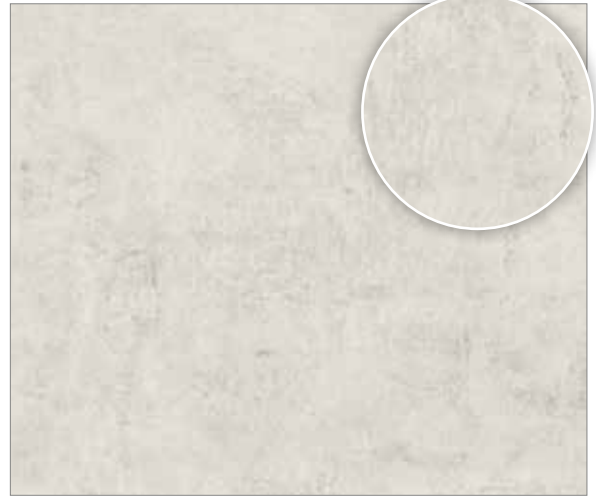

Lunar



Mayville Concrete

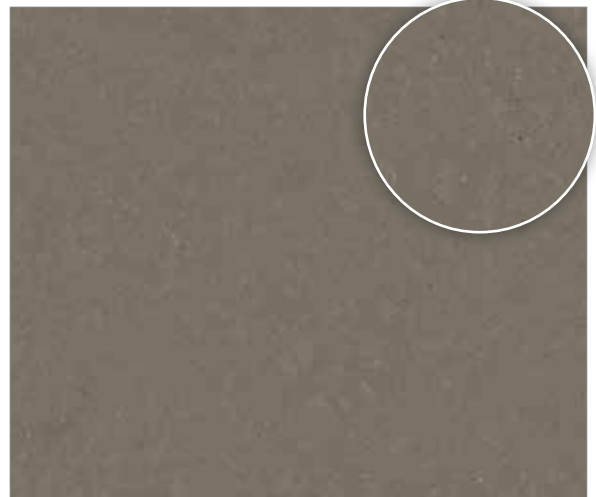

Brass Relish



Barbican Concrete



Argentium



ULTRA COMPACT

QUARTZ

GRANITE

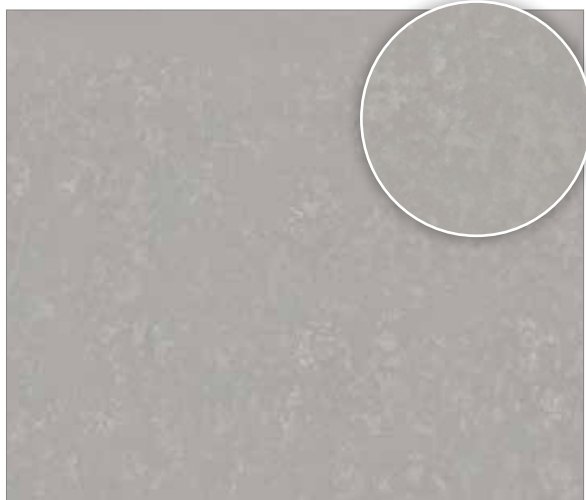

Poblenu

silestone Q+

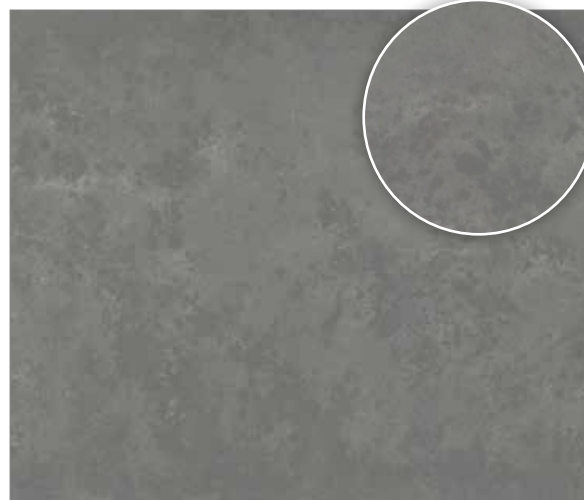

Seaport

silestone Q+

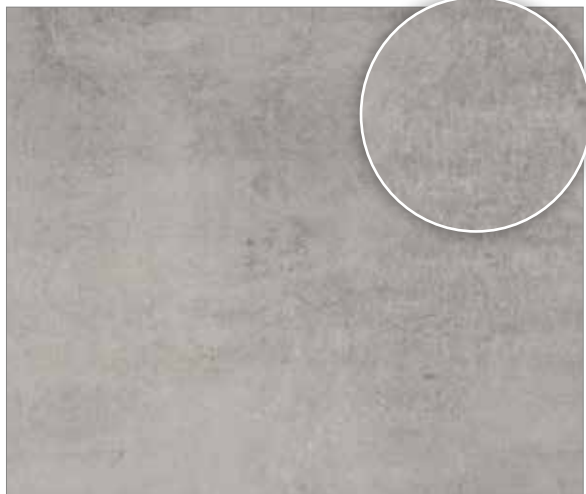

Kreta

DEKTON UC



Soke

DEKTON UC



Worksurface: Silestone Seaport

INDUSTRIAL COLLECTION

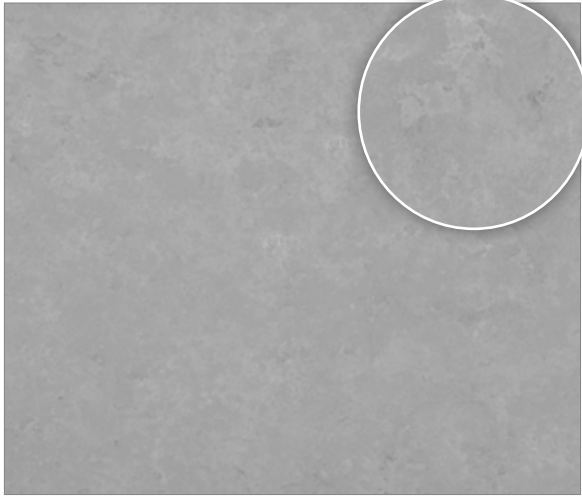

Trinity Concrete

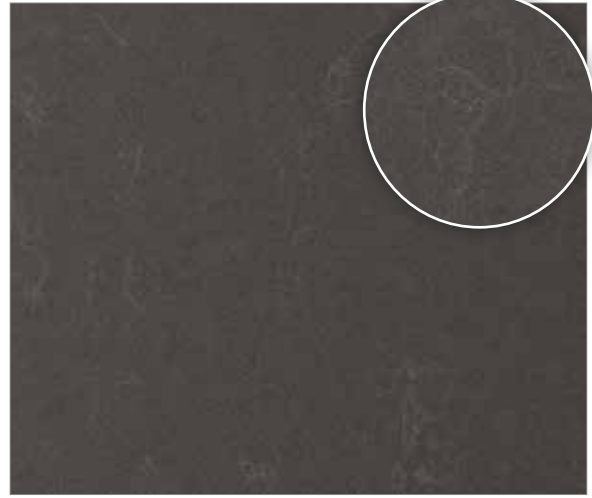

Balfron Concrete



Grafite



Trilium

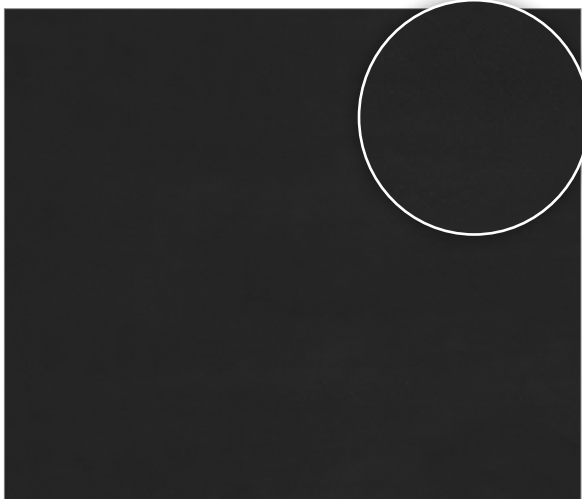

Domoos

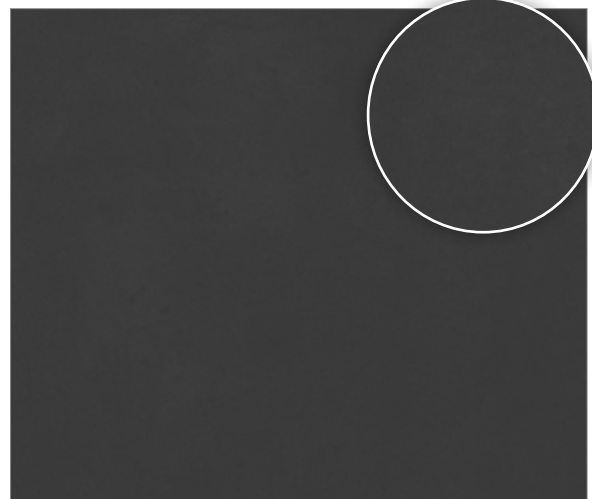

Sirius



ULTRA COMPACT

QUARTZ

GRANITE



Worksurface: Strata Quartz Trinity Concrete



TIMBER

COLLECTION

Natural and tactile

In recent years, there has been an increasingly popular desire to bring elements of nature into interior design. Embracing connections to the world, and a sense of bringing the beauty of outside in; opting for a wooden style worksurface is no longer associated with solely a country home aesthetic. Across a variety of tones and woodgrains, this Timber collection embodies the ideas of biophilic design, and enhances a warm and welcoming feel to any space.



TIMBER



CREATE THE LOOK

- 1 Worksurface: Strata Quartz Grigio Corchia
- 2 Worksurface: Strata Timber 40mm Walnut Finger Stave
- 3 Door Range: 1909 Ovolo in Copse Green
- 4 Handle: Walton Bar Handle Satin Pewter & Brass
- 5 Paint Colour: Regiment

TIMBER ENDGRAIN & NATURAL WOODGRAIN



Iroko



Rustic Oak (Full Stave)



Worksurface: Strata Timbers

ULTRA COMPACT

QUARTZ

GRANITE

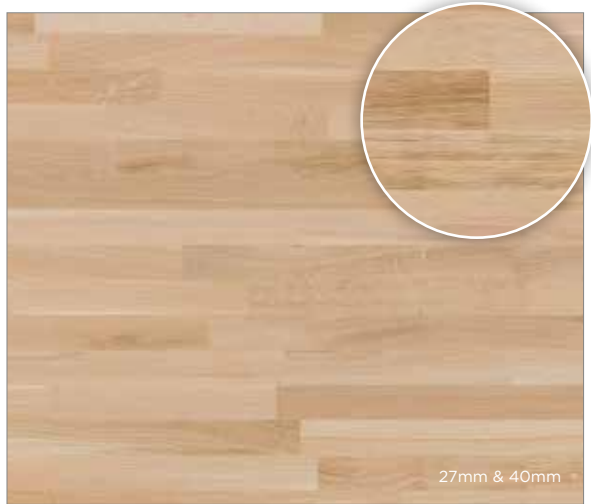

27mm & 40mm

Rustic Oak (Finger Stave)



27mm & 40mm

Oak



40mm

Prime Oak (Full Stave)



40mm

Strata Oak

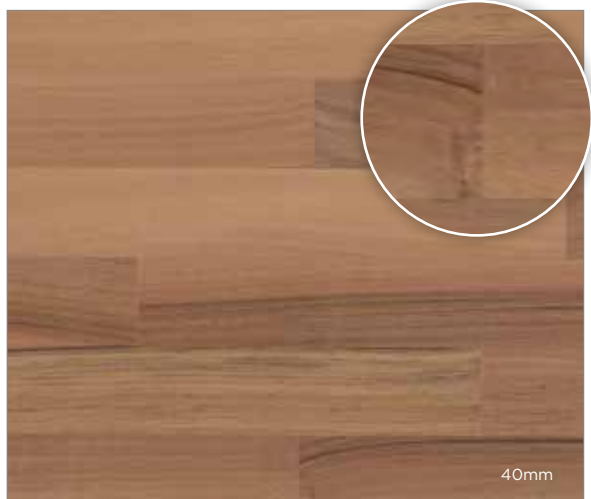

40mm

Walnut



60mm

Oak End Grain



FLIP TO OUR BACK PAGE FOR OUR ICON QUICK GUIDE





YOUR WORKSURFACE

Elements and style

Colour palette is just one element behind the worksurface that's right for you. Finding your perfect match means being confident you've chosen the best material for your lifestyle; considering its thickness and profiling; deciding on a sink style and whether to opt for drainer grooves; and picking a finish that appeals to you most. These are the nuances, the markers of personalisation and individuality to truly make a worksurface your own.

MATERIAL CHARACTERISTICS

Q QUARTZ

More consistent than granite and lower maintenance than marble, quartz is known for its durability, its resistance to chemicals and its ease to live with. It performs extremely well in busy kitchens thanks to its stain-resistance but comes in such an array of colours and finishes that it can appear delicate enough to even suit a bedroom's dressing area.



UC ULTRA COMPACT

There's something so tactile about this worksurface material that makes it incredibly satisfying to touch. But as soft and sophisticated as it is to look at, Ultra Compact is a material that's as tough as they come. Scratch and stain resistant, tolerant of high temperatures, and uniform in finish, it satisfies both function and form.



G GRANITE

Formed from natural rock, granite is one of the most renowned worksurface materials. Iconic for its dappled appearance, every cut of granite is unique, meaning no surface pattern is ever an exact replica. Immensely strong and durable, it's a failsafe option for those favouring natural stone.



HD NEW ULTRA HD QUARTZ

Ultra HD Quartz combines printed technological innovation with a focus on achieving a visually stunning and authentic natural stone appearance on a quartz body. Suitable for applications in various settings, such as worksurfaces, splashbacks and downstands where both durability and aesthetics are important.



T TIMBER

Once the mainstay of the quintessential country kitchen, wooden worksurfaces are now welcomed into city pads as much as those in the provinces. Natural and renewable with a look full of richness and warmth, ours come in a choice of two hardwoods - oak, walnut or iroko - and will only grow in character with use and time.



silestone

Silestone by Cosentino - Is the leading global hybrid surface, a formation of raw materials such as minerals and natural quartz. An environmental success story is the recent addition of the new Hybriq and Hybriq + technology, using 99% recycled water, 100% renewable electric energy as well as recycled materials. This is the worlds first zero carbon mineral surface.

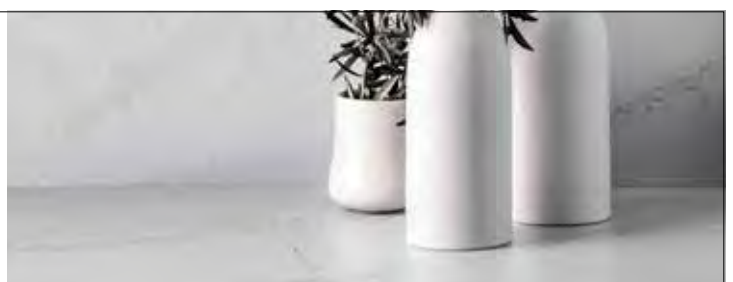



THE WORLD'S FIRST
ZERO CARBON
WORKSURFACES

FEATURING
HYBRIQ+
TECHNOLOGY®

Uncompromisingly strong and beautifully sleek, these surfaces blend recycled materials with quartz combining them using 99% recycled water and pure electric energy from renewable sources. It's craftsmanship with a conscience.

Look out for the **Q+** symbol amongst the Silestone swatches

20% Minimum Recycled Glass

98% Recycled Water

100% Renewable Energy

MATERIAL FINISH



LEATHER FINISH

Matte and buttery soft, akin to natural leather, though it will vary slightly depending onto which worksurface material it's applied.



RAW FINISH

A natural look with a rough, textured feel, this is a finish that convincingly replicates stone and industrial surfaces like poured concrete.



SMOOTH/SILK FINISH

Available on our Ultra Compact materials. This finish is a happy middle ground between matte and highly polished.



POLISHED FINISH

As the name suggests, this finish is all about high shine. It will also intensify the colour and clarity of your worksurface.



CONCRETE EFFECT FINISH

Designed to replicate the appearance and texture of natural concrete, adding an industrial touch to your worksurface.



SUEDE FINISH

Another matte option but with a softer, more velvety texture, this finish also offers a high-quality consistent colour.



VOLCANO FINISH

Think of lava's rustic appearance and touch, and imagine that on your worksurface. A smooth surface with subtle undulations.



CARESS FINISH

In a textured worksurface that isn't one smooth level, Caress accentuates and celebrates those rises and falls, adding final polish to its high points.



TEXTURED FINISH

An etched, patterned finish that adds depth and impact, particularly on solid coloured worksurfaces.

MATERIAL TECHNOLOGY



N-BOOST TECHNOLOGY

Your worksurface's DNA has been boosted to make it easier than ever to maintain and clean. This performance trait offers outstanding resistance to stains, extraordinary shine and helps lock in colour intensity.



FULL STAVE CONSTRUCTION

Applicable to our timber worksurfaces where the wood runs the full length to avoid any visible joints.



END GRAIN

Popular on chopping boards and butcher's blocks, this is when the wood is cut across its growth rings, resulting in a striking, multi-layered surface full of variation.



FINGER STAVE CONSTRUCTION

A wooden treatment where the joints are visible, finger staving features short, thin staves of wood bonded together by glue.



HYBRIQ+

Silestone Hybriq+ by Cosentino ZERO CARBON hybrid mineral surfaces manufactured using 100% renewable energy, 98% recycled water & 20% minimum recycled glass, with the added bonus of reduced percentage of crystalline silica maximum 50%.



DEKTON GRIP

Dekton Grip offers a smooth finish similar to the standard version, enhanced with advanced treatment to ensure reliable slip-resistance.

MATERIAL TECHNOLOGY

DEKTON® 
designed by COSENTINO



HEAT PROOF

Dekton and Lundhs surfaces are highly heat-resistant, capable of withstanding extremely high temperatures. Fire and heat won't damage these surfaces, making them exceptionally durable and reliable for various applications.



OUTDOOR USE

Dekton and Lundhs worksurfaces are ideal for outdoor use. They offer exceptional resistance to high temperatures, stains, and impacts. Additionally, they withstand external climatic factors such as frost, sun, hail, and wind.

SINK STYLE

Spanning from classic ceramic, elegant undermounts, to striking down-stand designs, sinks offer a diverse range of styles, providing countless combinations to complement your ideal worksurface.

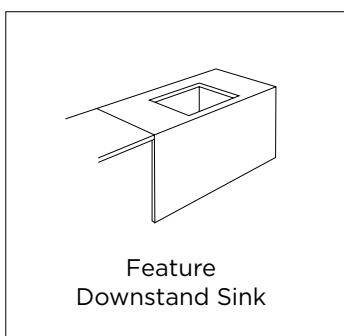
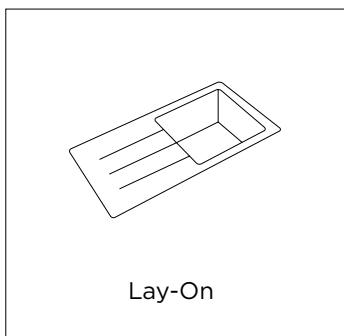
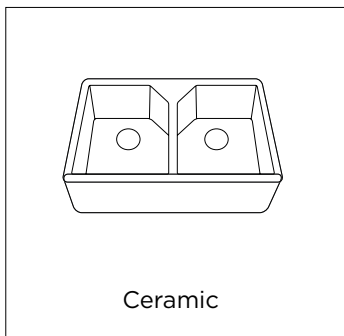
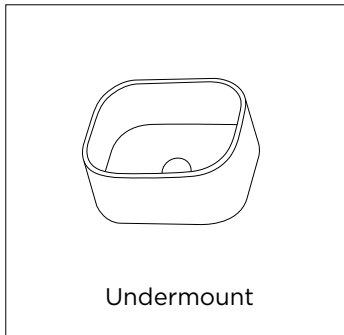
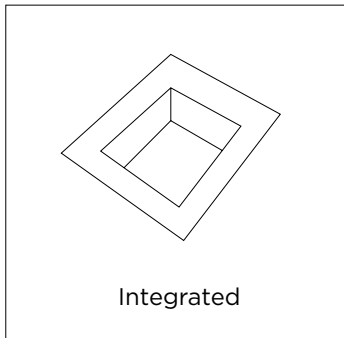

DRAINER STYLE

Enhance your kitchen's aesthetics and functionality with drainer grooves, a stylish addition that elevates the look of your worktops. Placed on either side of the sink, you can tailor them to perfectly complement your ideal sink setup.

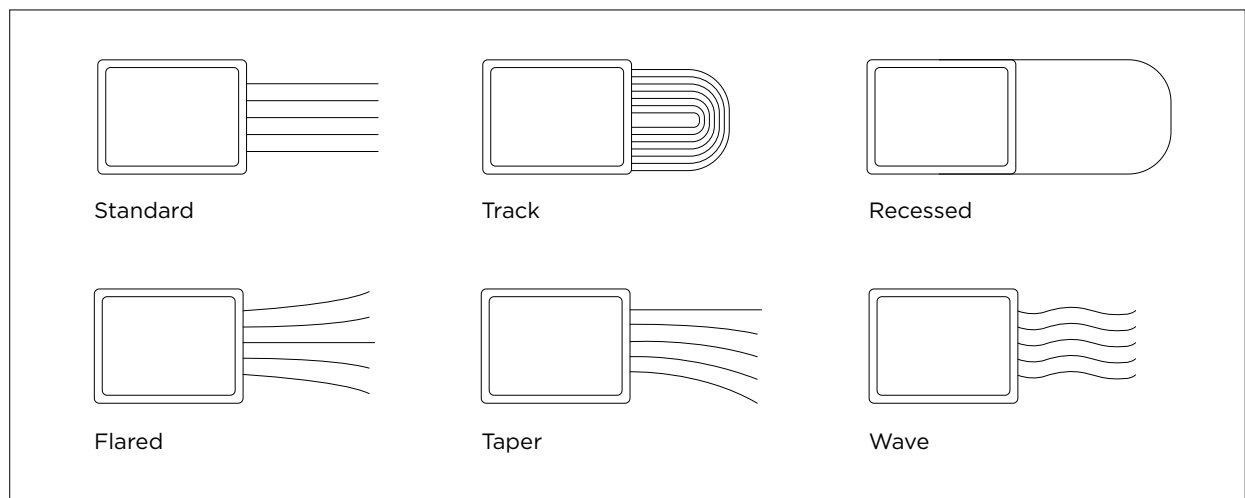

Worksurface: Strata Quartz Rosa Astratto

UPSTAND STYLE

By incorporating complementary kitchen upstands, you can elevate the already impressive appearance of your stunning worksurface, creating an air of unparalleled sophistication.

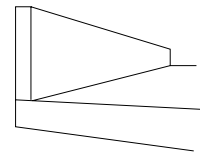

Upstand

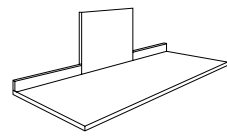
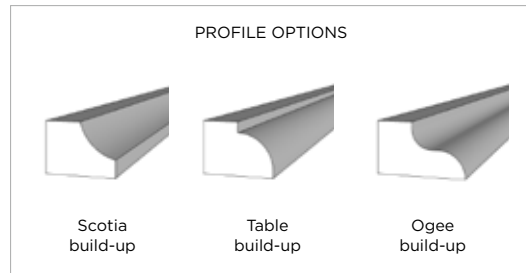
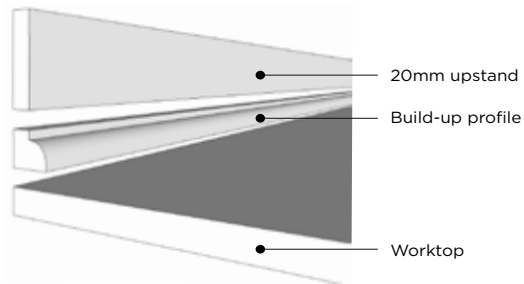

Splashback

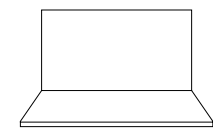

Cladding

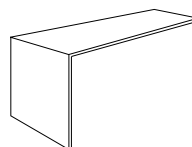

Downstand

FLOATING SHELVES

Enhance both the functionality and elegance of your upstand with the addition of a beautifully designed floating shelf, ideal for showcasing matching decorations or storing essential kitchen utensils.



Worksurface: Dekton Ultra Compact Trance

NEW FABRICATION PROCESSES



FLOATING BREAKFAST BAR

Unveiling our new floating island application in response to the need for practical areas free from limitations.



EXTRACTOR HOUSING

We have created a cladding option as a straightforward way to hide the extractor housing, creating a sleek and modern look instead.



Worksurface: Strata Calacatta Gold

THICKNESS STYLE

20mm or 30mm might be the go-to thickness for worksurfaces but these are just conversation starters. Where you choose to take your worksurface is entirely your choice...

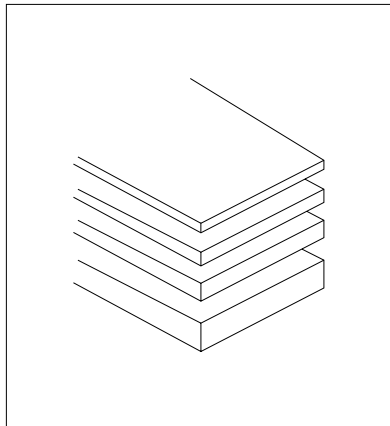

EDGE STYLE

It's the small details that truly set your kitchen apart. The choice of edge for your worksurface can profoundly influence the overall ambiance. Whether you prefer a classic curve or a sleek, modern straight edge, there are numerous styles to tailor your worksurface to match your kitchen's unique style and aesthetic.

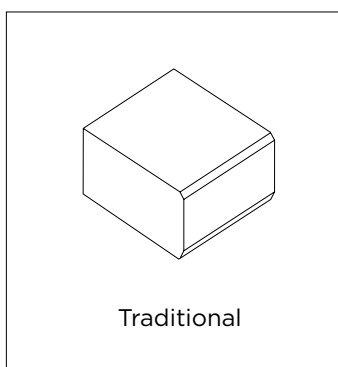
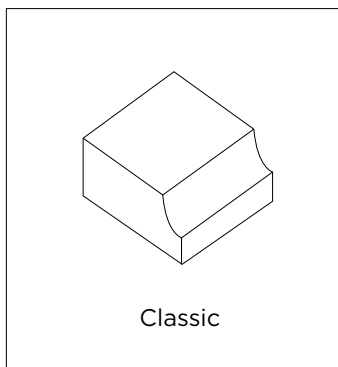
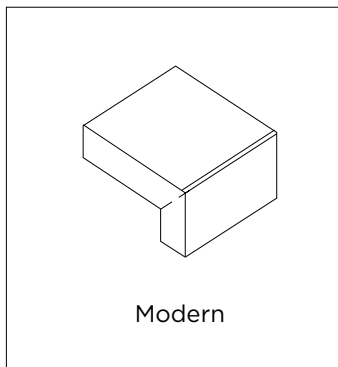



SPECIALISTS FROM START TO FINISH

History and reputation

Materials, details and finishing touches alone do not make an everlasting worksurface. It takes a team of experts in their field to bring together all the elements and bind them into a masterpiece that you'll be able to love and use day in day out for a lifetime. Based here in the UK, we've been masters in worksurface design, making and fitting for decades. And it's because of our history and reputation that we've been able to build a material supply network from the world's most esteemed sources, to guarantee you a surface that's remarkably high quality in every regard.







PRECISION TEMPLATING

Your worksurface is designed to your exacting requirements, and that applies to its made-to-measure sizing too. One of our templating experts will visit your home to digitally map and measure your dimensions to promise millimetre perfection.

BESPOKE MANUFACTURING

When worksurfaces are authentically made, it's somewhat of an art - one we're proud to have honed and mastered. Every one of our worksurfaces is handmade to order with our sculptors pouring over every last detail that you've personally chosen.

SPECIALIST INSTALLATION

Your worksurface will only ever be delivered and fitted by one of our accredited installers. They'll also guide you on how to clean and care for it before leaving your home.

PREMIUM AFTERCARE

From the moment your worksurface is installed, we guarantee you, as the registered owner, for manufacturing defects up to a decade. This way, you know that our care and support is always at your side, just as your worksurface will be for year, after year, after year.



BROUGHT TO YOU BY



WORKSURFACES

July 2024

QUICK REFERENCE KEY

LEAVE OPEN, OR USE
AS A BOOKMARK



LEATHER FINISH



SUEDE FINISH



RAW FINISH



VOLCANO FINISH



SMOOTH/SILK FINISH



CARESS FINISH



POLISHED FINISH



CONCRETE EFFECT
FINISH



TEXTURED FINISH



HEAT PROOF



N-BOOST TECHNOLOGY



DEKTON GRIP



ULTRA HD QUARTZ



FINGER STAVE
CONSTRUCTION



FULL STAVE
CONSTRUCTION



END GRAIN



HYBRIQ +



HYBRIQ